

## CD4093BM/CD4093BC Quad 2-Input NAND Schmitt Trigger

### General Description

The CD4093B consists of four Schmitt-trigger circuits. Each circuit functions as a 2-input NAND gate with Schmitt-trigger action on both inputs. The gate switches at different points for positive and negative-going signals. The difference between the positive ( $V_{T^+}$ ) and the negative voltage ( $V_{T^-}$ ) is defined as hysteresis voltage ( $V_H$ ).

All outputs have equal source and sink currents and conform to standard B-series output drive (see Static Electrical Characteristics).

### Features

- Wide supply voltage range 3.0V to 15V
- Schmitt-trigger on each input with no external components
- Noise immunity greater than 50%

- Equal source and sink currents
- No limit on input rise and fall time
- Standard B-series output drive
- Hysteresis voltage (any input)  $T_A = 25^\circ\text{C}$

Typical	$V_{DD} = 5.0\text{V}$	$V_H = 1.5\text{V}$
	$V_{DD} = 10\text{V}$	$V_H = 2.2\text{V}$
	$V_{DD} = 15\text{V}$	$V_H = 2.7\text{V}$
Guaranteed		$V_H = 0.1 V_{DD}$

### Applications

- Wave and pulse shapers
- High-noise-environment systems
- Monostable multivibrators
- Astable multivibrators
- NAND logic

### Connection Diagram

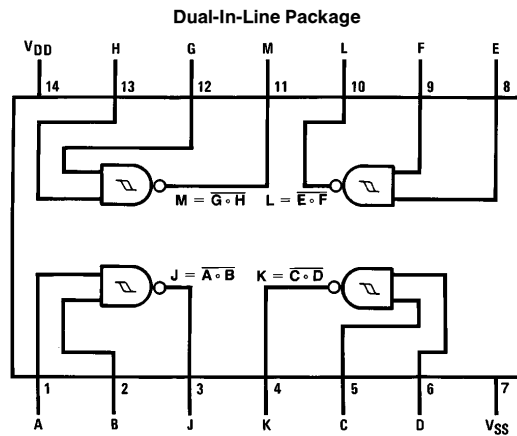

TL/F/5982-1

Top View

Order Number CD4093B

### Absolute Maximum Ratings (Notes 1 & 2)

If Military/Aerospace specified devices are required, please contact the National Semiconductor Sales Office/Distributors for availability and specifications.

DC Supply Voltage ( $V_{DD}$ )	-0.5 to +18 $V_{DC}$
Input Voltage ( $V_{IN}$ )	-0.5 to $V_{DD}$ + 0.5 $V_{DC}$
Storage Temperature Range ( $T_S$ )	-65°C to +150°C
Power Dissipation ( $P_D$ )	
Dual-In-Line	700 mW
Small Outline	500 mW
Lead Temperature ( $T_L$ )	
(Soldering, 10 seconds)	260°C

### Recommended Operating Conditions (Note 2)

DC Supply Voltage ( $V_{DD}$ )	3 to 15 $V_{DC}$
Input Voltage ( $V_{IN}$ )	0 to $V_{DD}$ $V_{DC}$
Operating Temperature Range ( $T_A$ )	
CD4093BM	-55°C to +125°C
CD4093BC	-40°C to +85°C

### DC Electrical Characteristics CD4093BM (Note 2)

Symbol	Parameter	Conditions	-55°C		+25°C			+125°C		Units
			Min	Max	Min	Typ	Max	Min	Max	
$I_{DD}$	Quiescent Device Current	$V_{DD} = 5V$		0.25			0.25		7.5	$\mu A$
		$V_{DD} = 10V$		0.5			0.5		15.0	$\mu A$
		$V_{DD} = 15V$		1.0			1.0		30.0	$\mu A$
$V_{OL}$	Low Level Output Voltage	$V_{IN} = V_{DD},  I_O  < 1 \mu A$								
		$V_{DD} = 5V$		0.05		0	0.05		0.05	V
		$V_{DD} = 10V$		0.05		0	0.05		0.05	V
		$V_{DD} = 15V$		0.05		0	0.05		0.05	V
$V_{OH}$	High Level Output Voltage	$V_{IN} = V_{SS},  I_O  < 1 \mu A$								
		$V_{DD} = 5V$	4.95		4.95	5		4.95		V
		$V_{DD} = 10V$	9.95		9.95	10		9.95		V
		$V_{DD} = 15V$	14.95		14.95	15		14.95		V
$V_{T^-}$	Negative-Going Threshold Voltage (Any Input)	$ I_O  < 1 \mu A$								
		$V_{DD} = 5V, V_O = 4.5V$	1.3	2.25	1.5	1.8	2.25	1.5	2.3	V
		$V_{DD} = 10V, V_O = 9V$	2.85	4.5	3.0	4.1	4.5	3.0	4.65	V
		$V_{DD} = 15V, V_O = 13.5V$	4.35	6.75	4.5	6.3	6.75	4.5	6.9	V
$V_{T^+}$	Positive-Going Threshold Voltage (Any Input)	$ I_O  < 1 \mu A$								
		$V_{DD} = 5V, V_O = 0.5V$	2.75	3.65	2.75	3.3	3.5	2.65	3.5	V
		$V_{DD} = 10V, V_O = 1V$	5.5	7.15	5.5	6.2	7.0	5.35	7.0	V
		$V_{DD} = 15V, V_O = 1.5V$	8.25	10.65	8.25	9.0	10.5	8.1	10.5	V
$V_H$	Hysteresis ( $V_{T^+} - V_{T^-}$ ) (Any Input)	$V_{DD} = 5V$	0.5	2.35	0.5	1.5	2.0	0.35	2.0	V
		$V_{DD} = 10V$	1.0	4.30	1.0	2.2	4.0	0.70	4.0	V
		$V_{DD} = 15V$	1.5	6.30	1.5	2.7	6.0	1.20	6.0	V
$I_{OL}$	Low Level Output Current (Note 3)	$V_{IN} = V_{DD}$								
		$V_{DD} = 5V, V_O = 0.4V$	0.64		0.51	0.88		0.36		$m A$
		$V_{DD} = 10V, V_O = 0.5V$	1.6		1.3	2.25		0.9		$m A$
		$V_{DD} = 15V, V_O = 1.5V$	4.2		3.4	8.8		2.4		$m A$
$I_{OH}$	High Level Output Current (Note 3)	$V_{IN} = V_{SS}$								
		$V_{DD} = 5V, V_O = 4.6V$	-0.64		0.51	-0.88		-0.36		$m A$
		$V_{DD} = 10V, V_O = 9.5V$	-1.6		-1.3	-2.25		-0.9		$m A$
		$V_{DD} = 15V, V_O = 13.5V$	-4.2		-3.4	-8.8		-2.4		$m A$
$I_{IN}$	Input Current	$V_{DD} = 15V, V_{IN} = 0V$		-0.1		$-10^{-5}$	-0.1		-1.0	$\mu A$
		$V_{DD} = 15V, V_{IN} = 15V$		0.1		$10^{-5}$	0.1		1.0	$\mu A$

**Note 1:** "Absolute Maximum Ratings" are those values beyond which the safety of the device cannot be guaranteed; they are not meant to imply that the devices should be operated at these limits. The table of "Recommended Operating Conditions" and "Electrical Characteristics" provides conditions for actual device operation.

**Note 2:**  $V_{SS} = 0V$  unless otherwise specified.

**Note 3:**  $I_{OH}$  and  $I_{OL}$  are tested one output at a time.

DC Electrical Characteristics CD4093BC (Note 2)											
Symbol	Parameter	Conditions	-40°C		+25°C			+85°C		Units	
			Min	Max	Min	Typ	Max	Min	Max		
I <sub>DD</sub>	Quiescent Device Current	V <sub>DD</sub> = 5V		1.0				1.0		7.5	μA
		V <sub>DD</sub> = 10V		2.0				2.0		15.0	μA
		V <sub>DD</sub> = 15V		4.0				4.0		30.0	μA
V <sub>OL</sub>	Low Level Output Voltage	V <sub>IN</sub> = V <sub>DD</sub> ,  I <sub>O</sub>   < 1 μA									
		V <sub>DD</sub> = 5V		0.05		0	0.05		0.05		V
		V <sub>DD</sub> = 10V		0.05		0	0.05		0.05		V
V <sub>OH</sub>	High Level Output Voltage	V <sub>IN</sub> = V <sub>SS</sub> ,  I <sub>O</sub>   < 1 μA									
		V <sub>DD</sub> = 5V	4.95		4.95	5		4.95			V
		V <sub>DD</sub> = 10V	9.95		9.95	10		9.95			V
V <sub>T<sup>-</sup></sub>	Negative-Going Threshold Voltage (Any Input)	V <sub>DD</sub> = 5V, V <sub>O</sub> = 4.5V	1.3	2.25	1.5	1.8	2.25	1.5	2.3		V
		V <sub>DD</sub> = 10V, V <sub>O</sub> = 9V	2.85	4.5	3.0	4.1	4.5	3.0	4.65		V
		V <sub>DD</sub> = 15V, V <sub>O</sub> = 13.5V	4.35	6.75	4.5	6.3	6.75	4.5	6.9		V
V <sub>T<sup>+</sup></sub>	Positive-Going Threshold Voltage (Any Input)	V <sub>DD</sub> = 5V, V <sub>O</sub> = 0.5V	2.75	3.6	2.75	3.3	3.5	2.65	3.5		V
		V <sub>DD</sub> = 10V, V <sub>O</sub> = 1V	5.5	7.15	5.5	6.2	7.0	5.35	7.0		V
		V <sub>DD</sub> = 15V, V <sub>O</sub> = 1.5V	8.25	10.65	8.25	9.0	10.5	8.1	10.5		V
V <sub>H</sub>	Hysteresis (V <sub>T<sup>+</sup></sub> - V <sub>T<sup>-</sup></sub> ) (Any Input)	V <sub>DD</sub> = 5V	0.5	2.35	0.5	1.5	2.0	0.35	2.0		V
		V <sub>DD</sub> = 10V	1.0	4.3	1.0	2.2	4.0	0.70	4.0		V
		V <sub>DD</sub> = 15V	1.5	6.3	1.5	2.7	6.0	1.20	6.0		V
I <sub>OL</sub>	Low Level Output Current (Note 3)	V <sub>IN</sub> = V <sub>DD</sub>									
		V <sub>DD</sub> = 5V, V <sub>O</sub> = 0.4V	0.52		0.44	0.88		0.36			mA
		V <sub>DD</sub> = 10V, V <sub>O</sub> = 0.5V	1.3		1.1	2.25		0.9			mA
I <sub>OH</sub>	High Level Output Current (Note 3)	V <sub>IN</sub> = V <sub>SS</sub>									
		V <sub>DD</sub> = 5V, V <sub>O</sub> = 4.6V	-0.52		0.44	-0.88		-0.36			mA
		V <sub>DD</sub> = 10V, V <sub>O</sub> = 9.5V	-1.3		-1.1	-2.25		-0.9			mA
I <sub>IN</sub>	Input Current	V <sub>DD</sub> = 15V, V <sub>IN</sub> = 0V		-0.3		-10 <sup>-5</sup>	-0.3		-1.0		μA
		V <sub>DD</sub> = 15V, V <sub>IN</sub> = 15V		0.3		10 <sup>-5</sup>	0.3		1.0		μA

### AC Electrical Characteristics\*

T<sub>A</sub> = 25°C, C<sub>L</sub> = 50 pF, R<sub>L</sub> = 200k, Input t<sub>r</sub>, t<sub>f</sub> = 20 ns, unless otherwise specified

Symbol	Parameter	Conditions	Min	Typ	Max	Units
t <sub>PHL</sub> , t <sub>PLH</sub>	Propagation Delay Time	V <sub>DD</sub> = 5V		300	450	ns
		V <sub>DD</sub> = 10V		120	210	ns
		V <sub>DD</sub> = 15V		80	160	ns
t <sub>THL</sub> , t <sub>TLH</sub>	Transition Time	V <sub>DD</sub> = 5V		90	145	ns
		V <sub>DD</sub> = 10V		50	75	ns
		V <sub>DD</sub> = 15V		40	60	ns
C <sub>IN</sub>	Input Capacitance	(Any Input)		5.0	7.5	pF
C <sub>PD</sub>	Power Dissipation Capacitance	(Per Gate)		24		pF

\*AC Parameters are guaranteed by DC correlated testing.

**Note 2:** V<sub>SS</sub> = 0V unless otherwise specified.

**Note 3:** I<sub>OH</sub> and I<sub>OL</sub> are tested one output at a time.

## Typical Applications

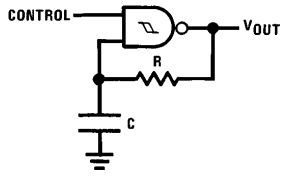

Assume  $t_1 + t_2 \gg t_{pHL} + t_{pLH}$  then:

$$t_0 = RC \ln [V_{DD}/V_{T-}]$$

$$t_1 = RC \ln [(V_{DD} - V_{T-})/(V_{DD} - V_{T+})]$$

$$t_2 = RC \ln [V_{T+}/V_{T-}]$$

$$f = \frac{1}{t_1 + t_2} = \frac{1}{RC \ln \frac{(V_{T+})(V_{DD} - V_{T-})}{(V_{T-})(V_{DD} - V_{T+})}}$$

### Gated Oscillator

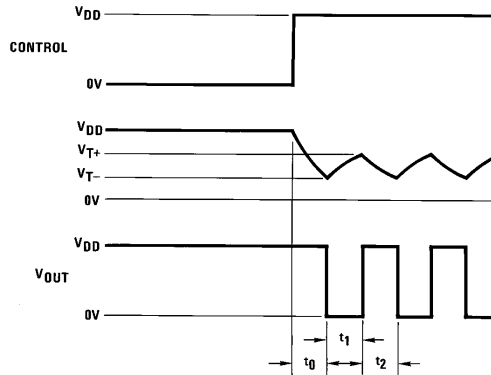

TL/F/5982-2

TL/F/5982-3

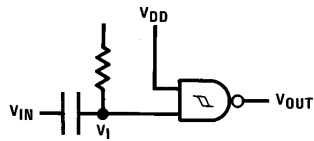

TL/F/5982-4

### Gated One-Shot

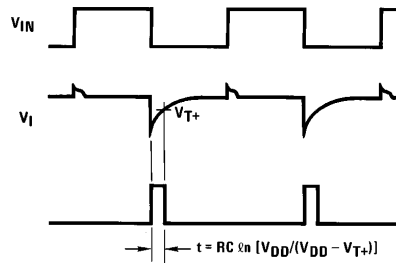

TL/F/5982-5

#### (a) Negative-Edge Triggered

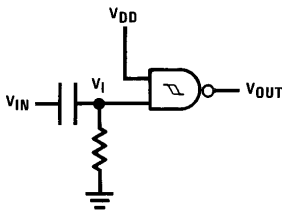

TL/F/5982-6

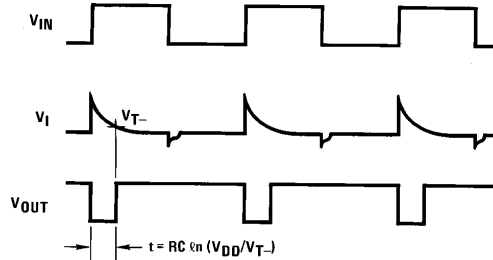

TL/F/5982-7

#### (b) Positive-Edge Triggered

## Typical Performance Characteristics

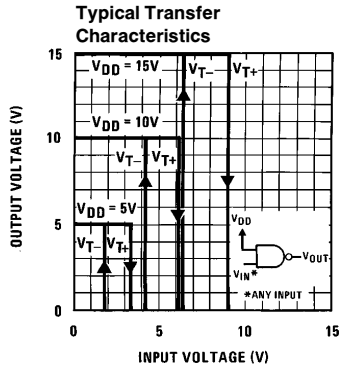

TL/F/5982-8

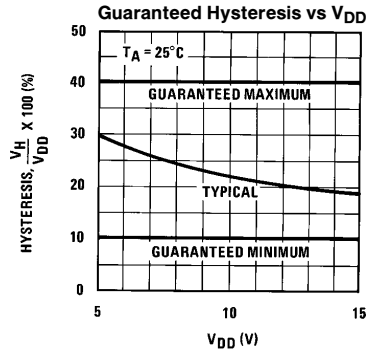

TL/F/5982-9

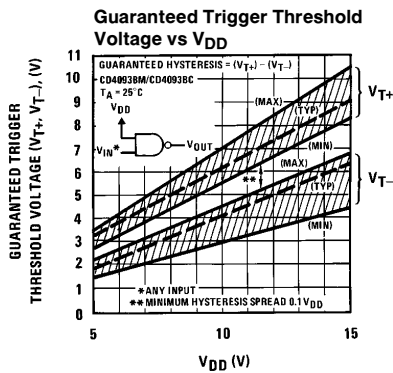

TL/F/5982-10

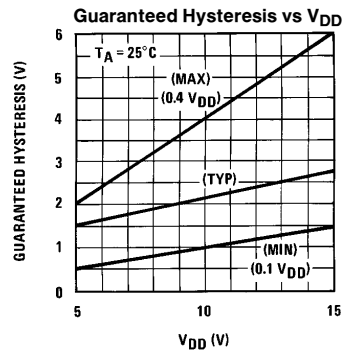

TL/F/5982-11

## Input and Output Characteristics

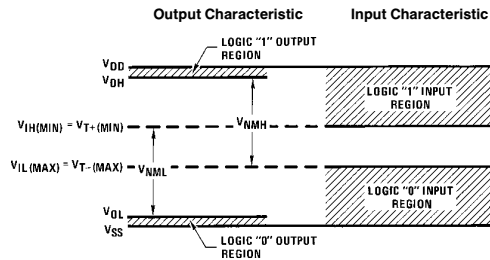
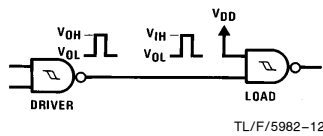

TL/F/5982-13

$$V_{NML} = V_{IH(MIN)} - V_{OL} \approx V_{IH(MIN)} = V_{T+ (MIN)}$$

$$V_{NMH} = V_{OH} - V_{IL(MAX)} \approx V_{DD} - V_{IL(MAX)} = V_{DD} - V_{T- (MAX)}$$

## AC Test Circuits and Switching Time Waveforms

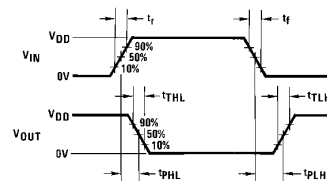
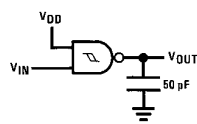

TL/F/5982-15

**Physical Dimensions** inches (millimeters)

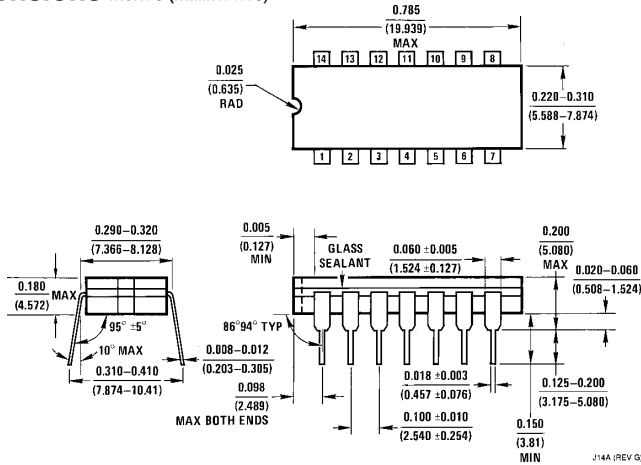

**Ceramic Dual-In-Line Package (J)**  
**Order Number CD4093BMJ or CD4093BCJ**  
**NS Package Number J14A**

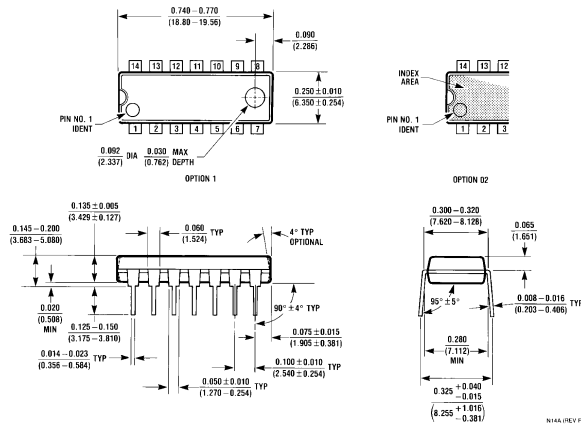

**Molded Dual-In-Line Package (N)**  
**Order Number CD4093BM or CD4093BCN**  
**NS Package Number N14A**