

**LED SPECIFICATION**

BLANCO 4000/8000 MCD 23\* WATER



**ATTENTION**

OBSERVE PRECAUTIONS  
FOR HANDLING  
ELECTROSTATIC  
DISCHARGE  
SENSITIVE  
DEVICES

**Features/特征:**

- I Single color/特征
- I High bright output/高亮度输出
- I Low power consumption/低功耗
- I High reliability and long life/可靠性高、寿命长
- I Cuprum lead/铜引脚

**Descriptions/描述:**

- I Dice material/芯片材质: GaInN
- I Emitting Color/发光颜色:  
Super Bright White/高亮度白色
- I Device Outline/产品外形:  
φ 8mm Round Type/8mm 圆形
- I Lens Type/胶体颜色: Water Clear/无色透明

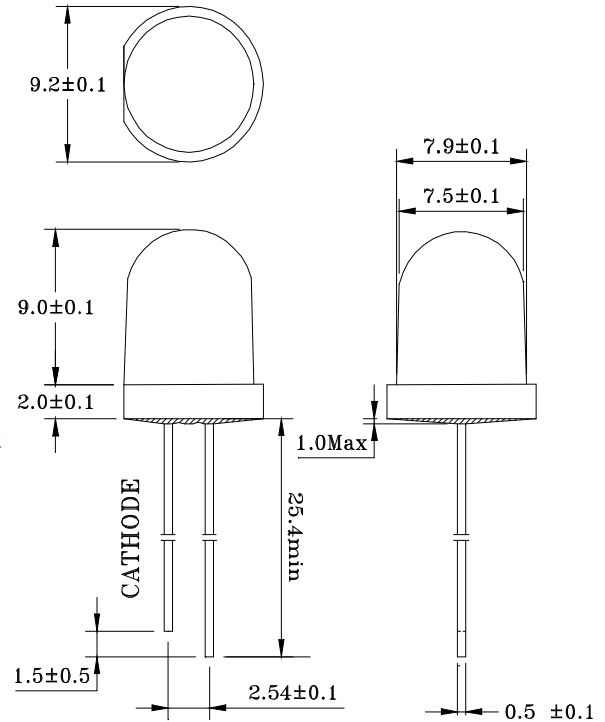

**NOTE/注意:**

- I All dimensions are millimeters/单位: mm
- I Tolerance is  $\pm 0.20 \text{ mm}$  unless otherwise noted/没有标注的公差为  $\pm 0.20 \text{ mm}$

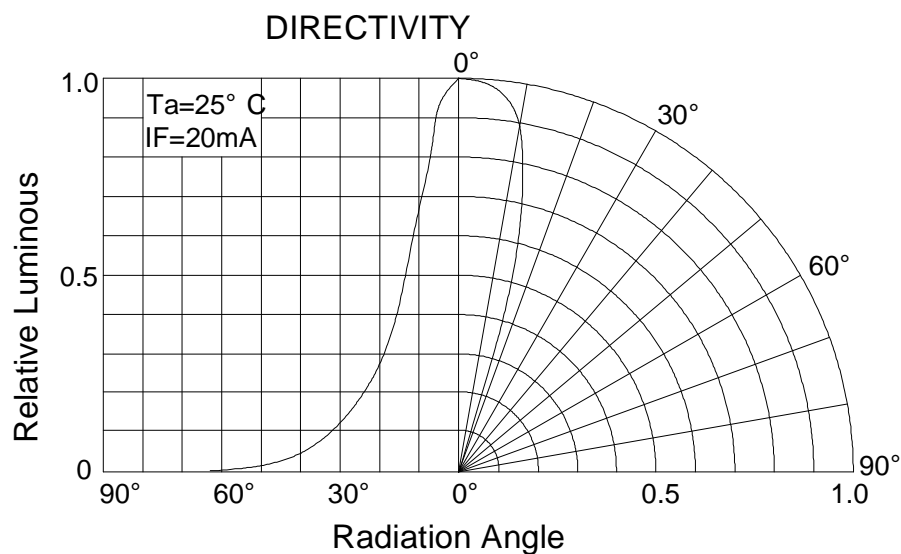

BLANCO 4000/8000 MCD 23\* WATER

**Absolute maximum ratings/极限参数 (Ta = 25°C)**

Parameter 参数	Symbol 符号	Test Condition 测试条件	Value 数值		Unit 单位
			Min.	Max.	
Reverse Voltage 反向电压	VR	IR = 30 μ A	5	--	V
Forward Current 正向工作电流	IF	----	----	25	mA
Power Dissipation 损耗功率	Pd	----	----	90	mW
Pulse Current 正向峰值电流	Ipeak	Duty=0.1mS, 1kHz	----	100	mA
Operating Temperature 工作温度范围	Topr	----	-40	+85	°C
Storage Temperature 储存温度范围	Tstr	----	-40	+100	°C

**Electrical and optical characteristics /光电参数 (Ta = 25°C)**

Parameter 参数	Symbol 符号	Test Condition 测试条件	Value 数值			Unit 单位
			Min.	Typ.	Max.	
Forward Voltage 正向电压	VF	IF = 20mA	----	3.2	3.6	V
Reverse Current 反向电流	IR	VR = 5V	----	----	30	μ A
Luminous Intensity 发光强度	IV	IF = 20mA	----	8000	----	mcd
Viewing Angle 指向角度	2 θ 1/2	IF = 20mA	----	----	30	Deg.

**Luminous Intensity Bins Chart/发光强度分档 (Ta = 25°C)**

Bin	X	Y	Z1	Z2
Min	4000	6000	8000	10000
Max	6000	8000	10000	12000

BLANCO 4000/8000 MCD 23\* WATER

**Chromaticity Coordinates Ranks /色坐标分档(IF=20mA Ta=25°C)**

Wa1	X	0.243	0.215	0.230	0.263	Wa2	X	0.263	0.246	0.264	0.280
	Y	0.200	0.230	0.250	0.220		Y	0.220	0.236	0.267	0.248
Wa3	X	0.246	0.230	0.248	0.264	Wb1	X	0.280	0.264	0.283	0.296
	Y	0.236	0.250	0.286	0.267		Y	0.248	0.267	0.305	0.276
Wb2	X	0.264	0.248	0.275	0.283	Wc1	X	0.296	0.287	0.330	0.330
	Y	0.267	0.286	0.321	0.305		Y	0.276	0.295	0.339	0.318
Wc2	X	0.287	0.283	0.330	0.330	Wc3	X	0.283	0.275	0.298	0.306
	Y	0.295	0.305	0.360	0.339		Y	0.305	0.321	0.350	0.332
Wc4	X	0.306	0.298	0.321	0.330	Wd1	X	0.330	0.330	0.361	0.356
	Y	0.332	0.350	0.379	0.360		Y	0.318	0.360	0.385	0.351
Wd2	X	0.330	0.321	0.366	0.361	Wf	X	0.356	0.366	0.391	0.380
	Y	0.360	0.379	0.419	0.385		Y	0.351	0.419	0.436	0.381

**CIE 1931 Chromaticity diagram**

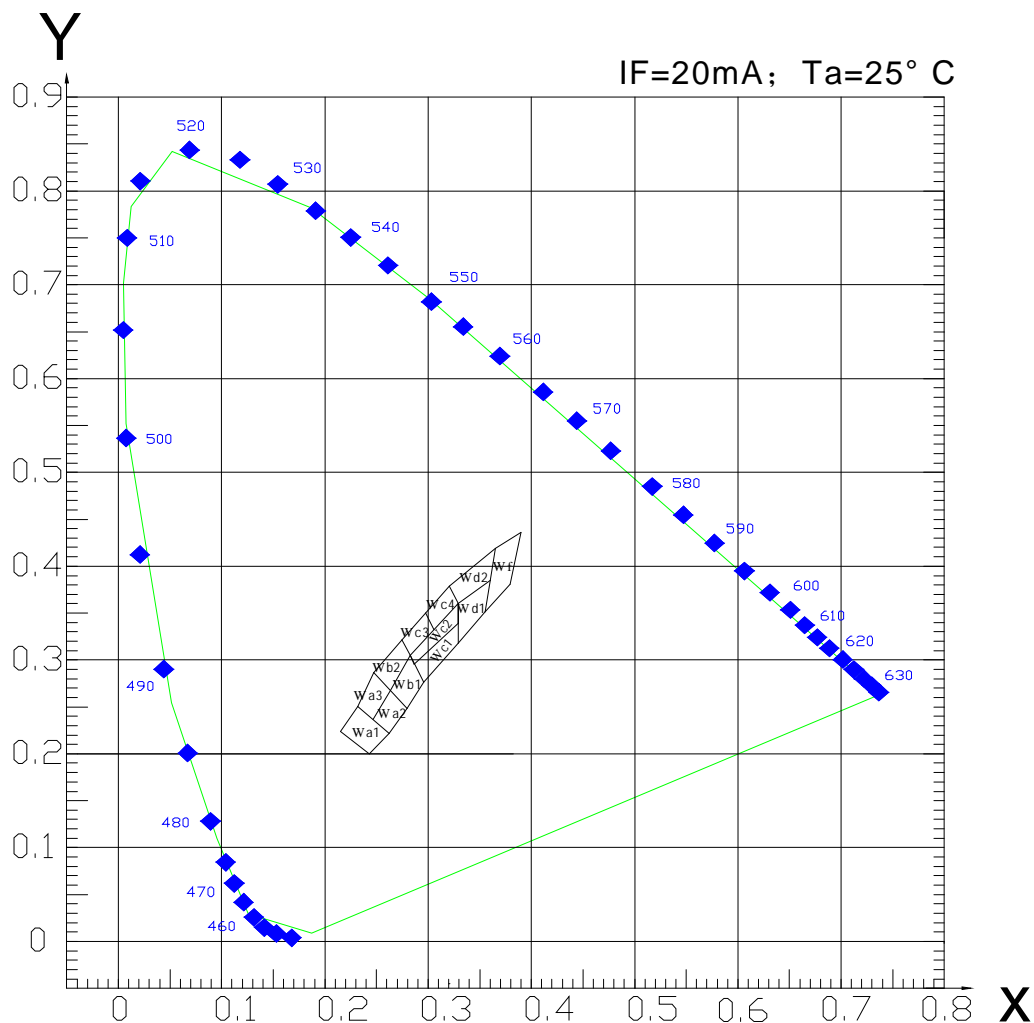

**Typical electrical/optical characteristic curves/光电特性曲线:**

Fig.1 正向电流 Vs. 正向电压

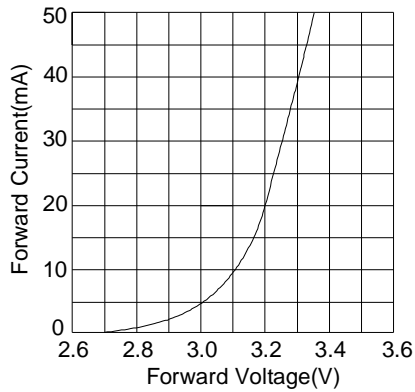

Fig.2 相对亮度 Vs. 正向电流

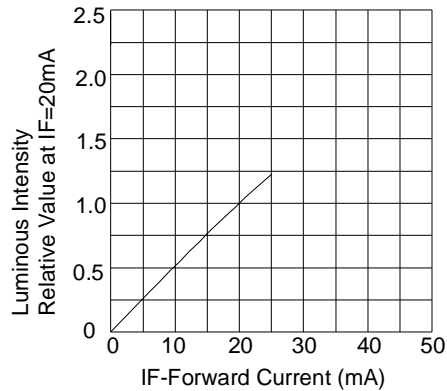

Fig.3 正向电流 Vs. 环境温度

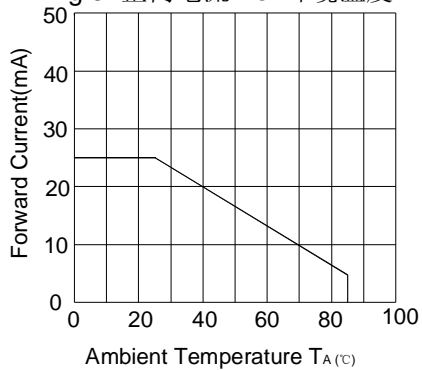
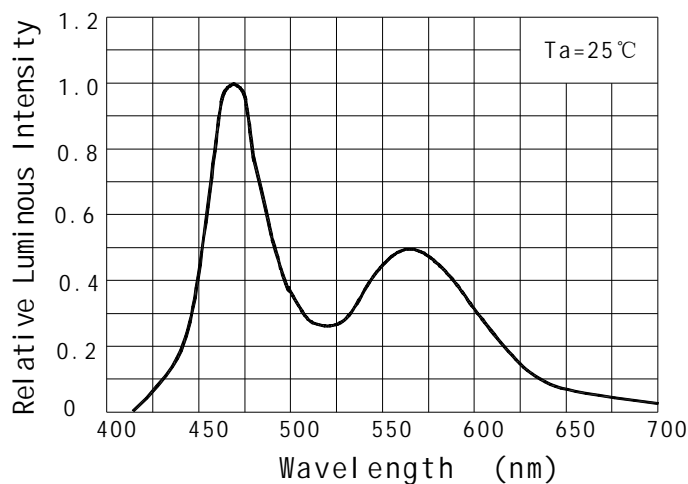
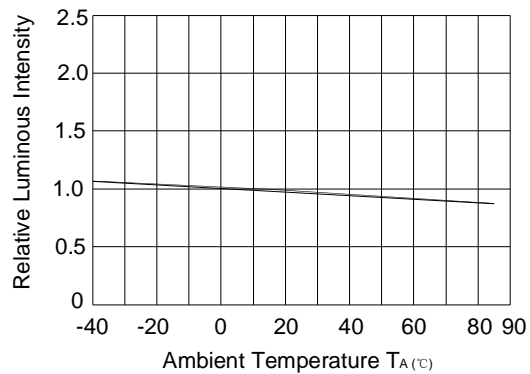

Fig.4 相对亮度 Vs. 环境温度



BLANCO 4000/8000 MCD 23\* WATER

**Life Test curves /寿命测试曲线**

