

M8 Transistor Tester (Ver.1602) Installation Instruction

Thank you for purchasing our M8 Transistor Tester Kit Tools. We believe our product will bring you an experience of convenience and accuracy.

Before your installation process, please carefully read this instruction, which will facilitate your installation in a more rapid and accurate way.

1. Installation:

The making of the casket should be finished according to the Casket Making Manual, if the casket installation is needed.

The first step is the Resistance Welding. If you are not familiar with the chromatic circle, please check the resistance with the multi-meter.

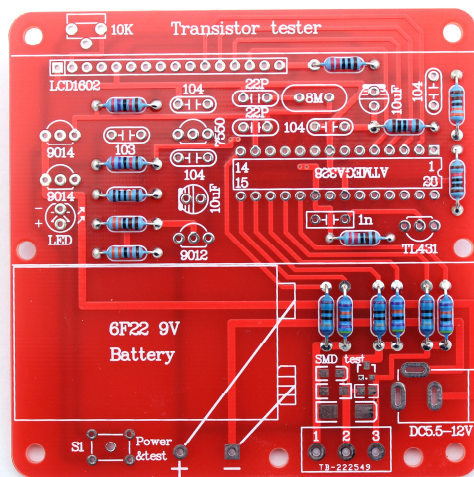

The electrode of the electrolytic capacitor should be aligned with the PCB side with white line.

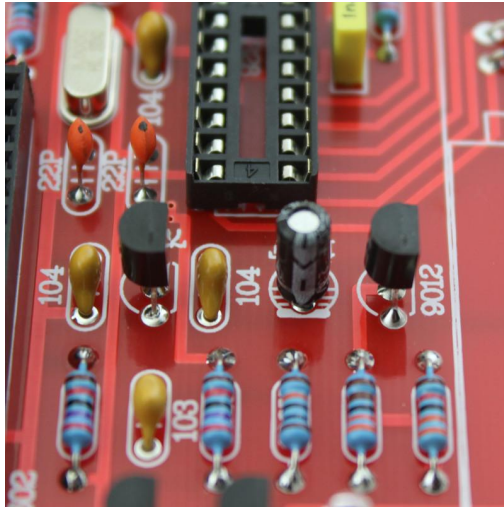

After all the welding jobs have been done, please connect the electric power instead of connecting Atmega328 and LCD(9V battery or external 5.5-12V DC power, outside -, inside +), and measuring the voltage of the pin7 and pin22 on the IC plug by using the multi-meter, and the voltage should be +5V(the button should be pushed when measuring), which means the circuit and power are working in normal condition.

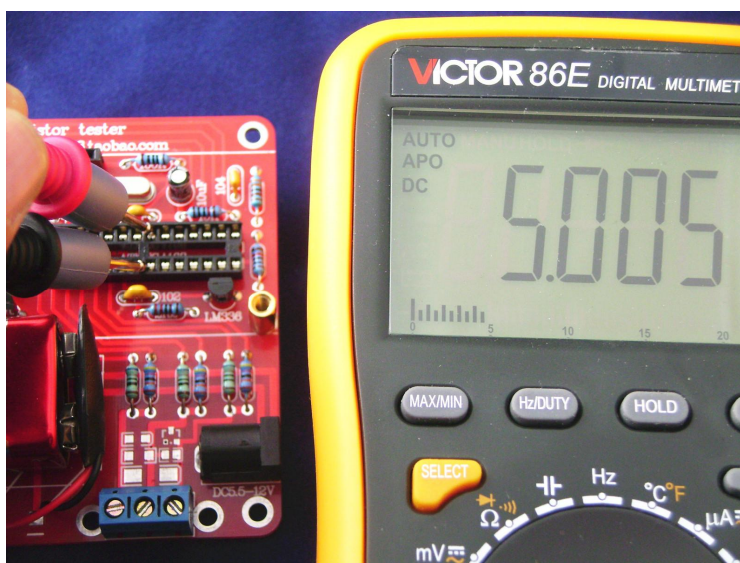

Cut off the power, and connect M328 and the LCD which is welded with the insert pin. Be aware of the direction of IC.

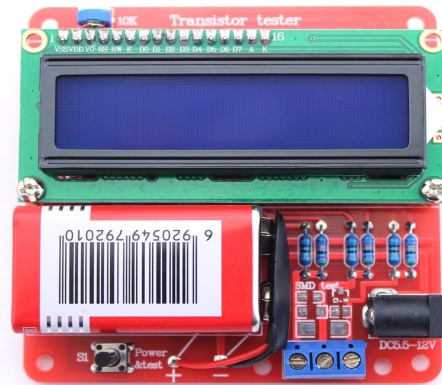
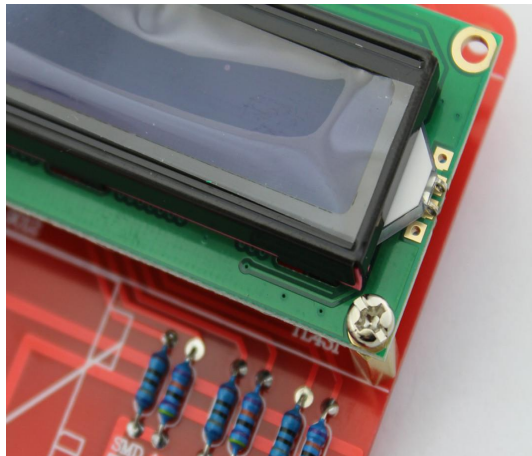
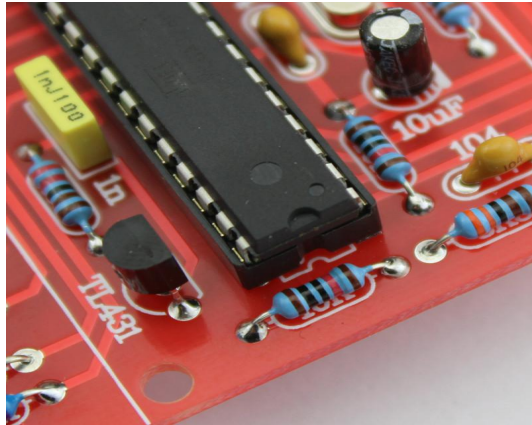

After all the installation, connect the power. Push the button, and maybe the screen will light without any character display. Don't be panic, right adjust the resistance and you will see the character.

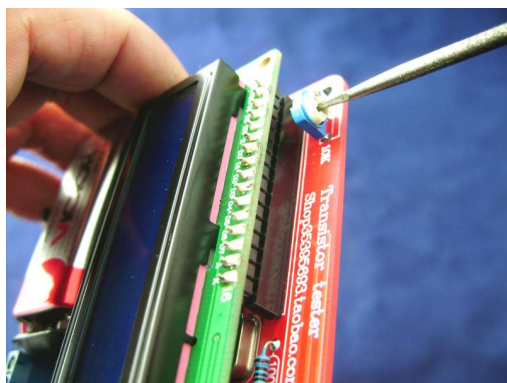

Adjust the character to clear type, and congratulations, the gadget could be put in use!

2. Selftest and Calibration

The selftest can be prepared by connecting all three test ports together and pushing of the button. To begin the self test, the test button must be pressed again within 2 seconds, or else the tester will continue with a normal measurement.

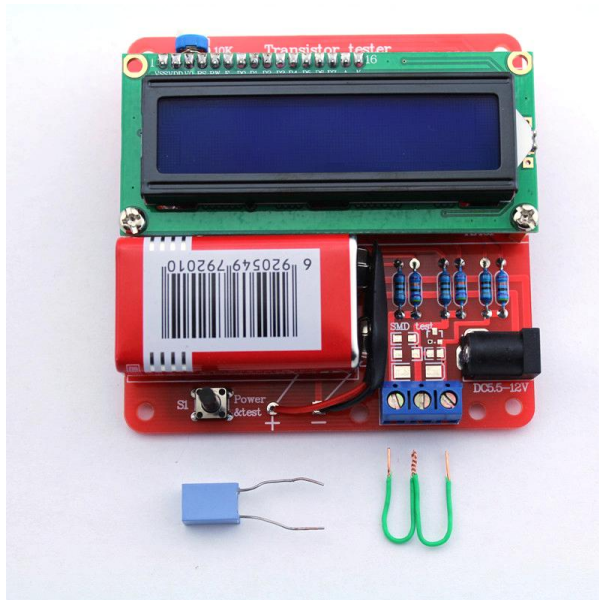

The test 4 (T4) will finish only automatically if you separate the test ports (release connection). **You should not touch to any of the test ports or connected cables when calibration is done.**

But the equipment should be the same, which is used for further measurements. Otherwise the zero offset for capacity measurement is not detected correctly. The resistance values of port outputs are determined at the beginning of every

measurement with this option.

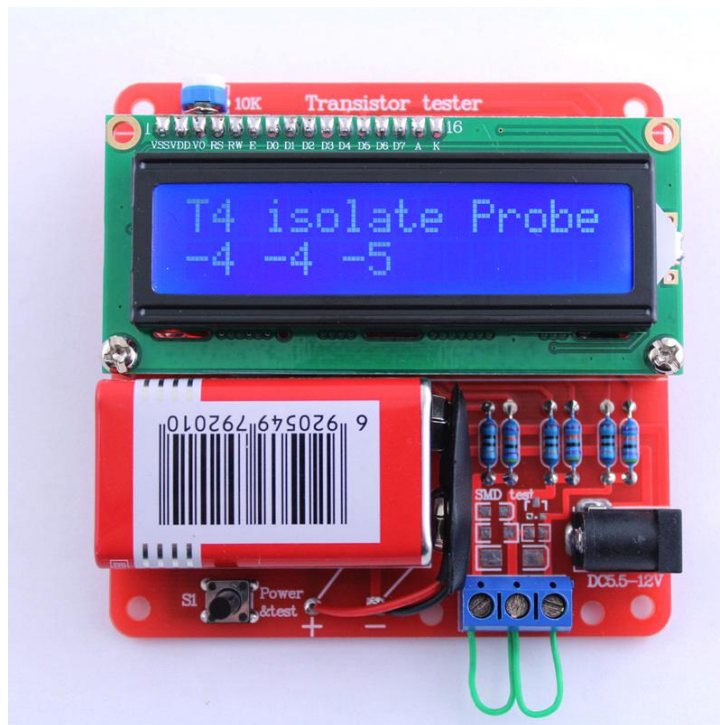

isolate Probe, which

means that it is time to separate the probes (release from wire).

A capacitor with any capacity between 100nF(0.1uF) and 20uF connected to pin 1 and pin 3 is required for the last task of calibration. **You should never use electrolytical capacitors, use film capacitors instead.**

To indicate that, a capacitor symbol is shown between the pin number 1 and 3, followed by the text ">100nF". **You should connect the capacitor not before this text is shown.** With this capacitor the offset voltage of the analog comparator will be compensated for better measurement of capacity values. Additionally the gain for ADC measurements using the internal reference voltage will be adjusted too with the

same capacitor for better resistor measurement results with the AUTOSCALE ADC option. If the menu option is selected for the tester and the selftest is not started as menu function, the calibration with the external capacitor is only done for the first time calibration. The calibration with the external capacitor can be repeated with a selftest call as menu selection.

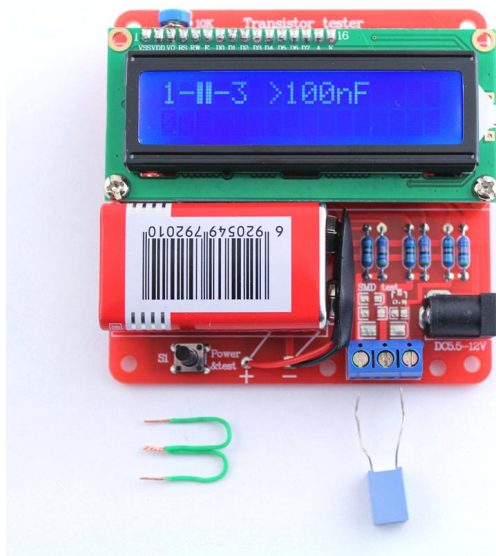

3. How to Use:

Using of the Transistor-Tester is simple. In either case you can connect parts with three pins to the three test ports in any order. If your part has only two pins, you can connect this pins to any two of the three test ports. Normally the polarity of part is irrelevant, you can also connect pins of electrolytical capacitors in any order. The measurement of capacity is normally done in a way, that the minus pole is at the test port with the lower

number. But, because the measurement voltage is only between 0.3 V and at most 1.3 V, the polarity doesn't matter. When the part is connected, you should not touch it during the measurement. You should put it down to a nonconducting pad if it is not placed in a socket.

You should also not touch to the isolation of wires connected with the test ports. Otherwise the measurement results can be affected. Then you should press the start button. After displaying a start message, the measurement result should appear after two seconds. If capacitors are measured, the time to result can be longer corresponding to the capacity.

The tester shut off automatic after displaying the result for 28 seconds for a longer lifetime of battery. During the display time a next measurement can be started by pressing the start button. After the shut off a next measurement can be started too of course. The next measurement can be done with the same or another part.

Components that could be measured include:

Resistance, capacitance, potentiometer, inductor, diode, LED, transistor, field-effect transistor, Thyristor, and so on.

Attention: Always be sure to discharge capacitors before

connecting them to the Tester! The Tester may be damaged before you have switched it on. There is only a little protection at the ATmega ports.

Resistance Measurement (1K, 0.05% tol and 680R\470K,0.1% tol) :

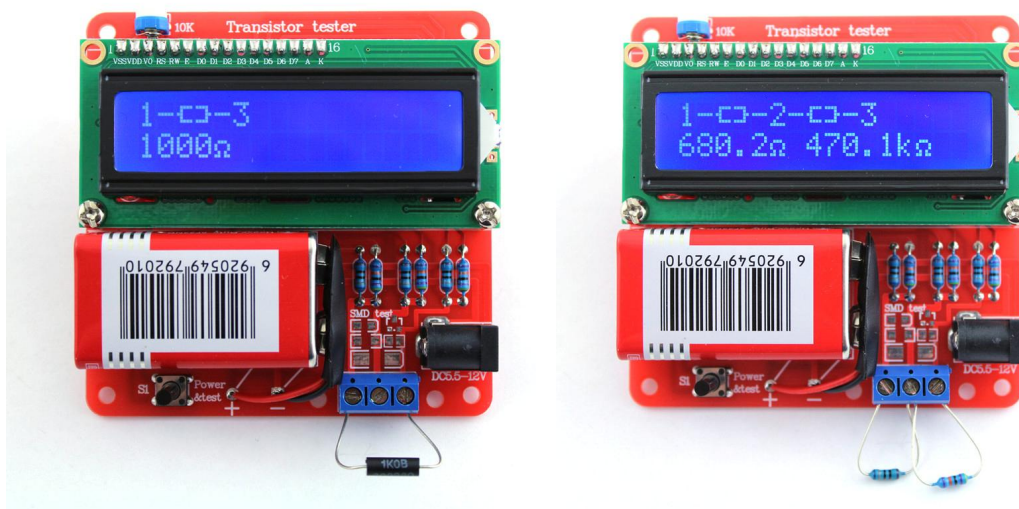

Up to two Resistors are measured and shown with symbols and values with up to four decimal digits in the right dimension. All symbols are surrounded by the probe numbers of the Tester (1-3). So Potentiometer can also be measured. If the Potentiometer is adjusted to one of its ends, the Tester cannot differ the middle pin and the end pin. Resolution of resistor measurement is now up to 0.01Ω, values up to 50MΩ are detected.

Non-Polarized Capacitance Measurement (1800PF 1% tol and

100nF 1% tol):

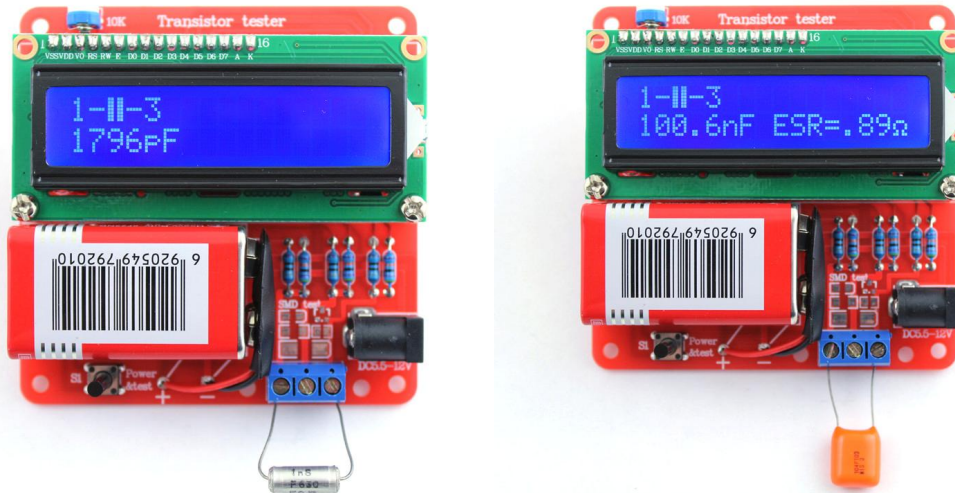

One capacitor can be detected and measured. It is shown with symbol and value with up to four decimal digits in the right dimension. The value can be from 25pF to 100mF(100000uF). The resolution can be up to 1pF (@8MHz clock). For capacitors with a capacity value above 90nF the Equivalent Serial Resistance (ESR) is measured with a resolution of 0.01 Ω and is shown with two significant decimal digits. For capacitors with a capacity value above 5000pF the voltage loss after a load pulse can be determined. The voltage loss give a hint for the quality factor of the capacitor.

Electrolytic capacitor measurement. When the capacity value is greater than 2uF it will display ESR value. There is no need to distinguish the polar when connected.

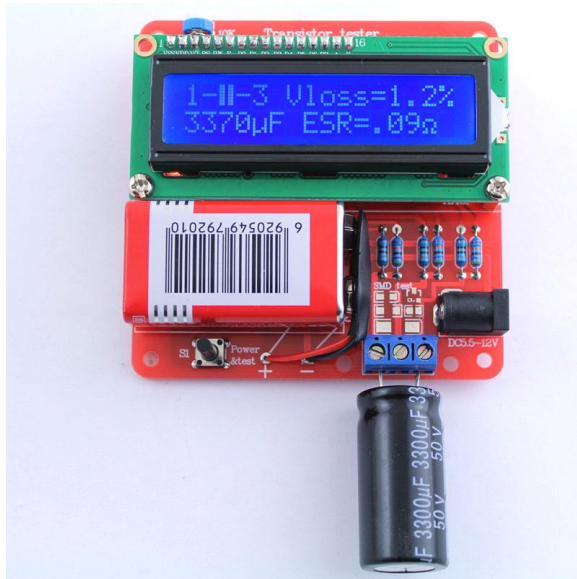

Inductance Measurement(0.1mH):



For resistors below 2100Ω also the measurement of inductance will be done. The range will be from about 0.01mH to more than 20H , but the accuracy is not good. The measurement result is only shown with a single component connected.

Transistor Measurement(2SA1941):



Display the Collector cutoff current I_{ce0} with currentless base (10uA units) and Collector residual current I_{ces} with base hold to emitter level . This values are only shown, if they are not zero (especially for Germanium transistors).

Thyristor Measurement(MCR100):



Thyristors and Triacs can only be detected, if the test current is above the holding current. Some Thyristors and Triacs need as higher gate trigger current, than this Tester can deliver. The available testing current is only about 6mA!

J-FET measurement(2SK30A):



MOS-FET measurement(IRFP40N10):



4. Optional menu functions for the ATmega328

If the menu function is selected, the tester start a selection menu after a long key press (>500ms) for additional functions. The selectable functions are shown in row two of a 2-line display.

After a longer wait time without any interaction the program leave the menu and returns to the normal transistor tester function. With a short key press the next selection can be shown. A longer key press starts the shown function. After showing the last function " switch off ", the first function will be shown next.

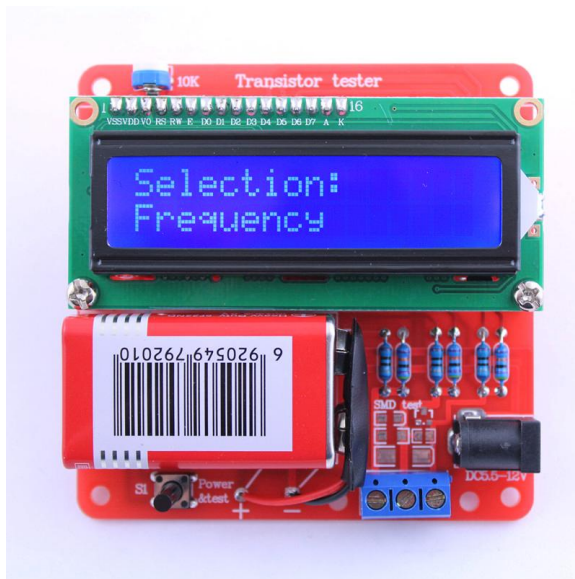

Frequency: (you need some additional components)

The additional function "frequency" (frequency measurement) uses the ATmega Pin PD4, which is also connected to the LCD.

First the frequency is allways measured by counting.

If the measured frequency is below 25kHz, additionally the mean period of the input signal is measured and with this value the frequency is computed with a resolution of up to 0.001Hz.

The frequency measurement will be finished with a key press and the selectable functions are shown again.

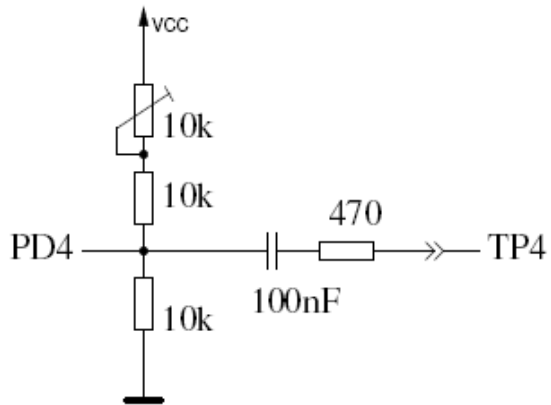

f-Generator(@TP2-3):

With the additional function "f-Generator" (frequency generator) the selectable frequencies can be switched with key presses.

After selecting the last choice of frequencies, the generator is switched back to the first frequency next (cyclical choice). With a long key press (> 0.8 s) you will stop the frequency generator and return to the function menu.

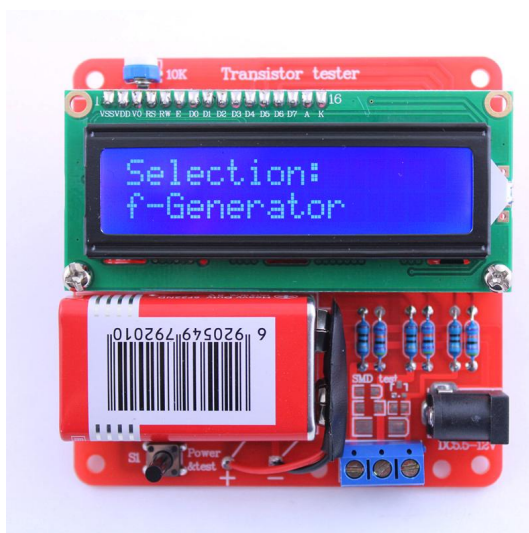

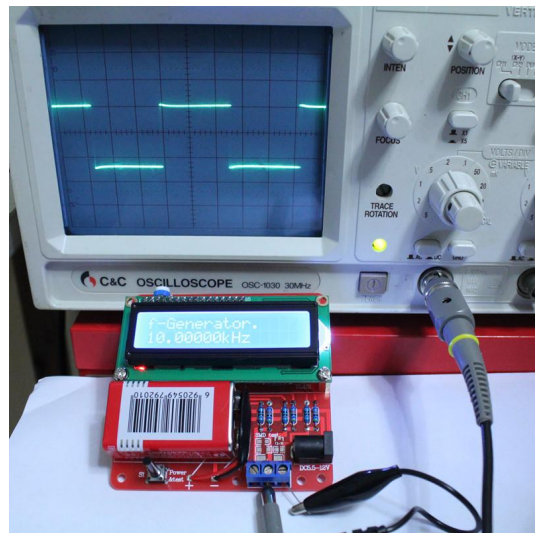
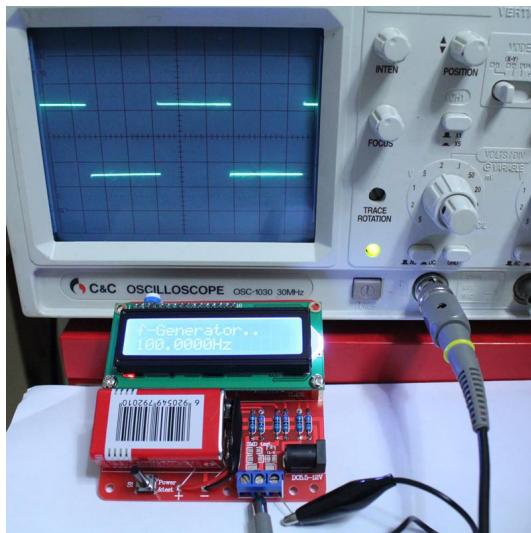

10-bit PWM(@TP2-3):

The additional function "10-bit PWM" (Pulse Width Modulation) generates a fixed frequency with selectable pulse width at the pin TP2. With a short key press (< 0.5 s) the pulse width is increased by 1%, with a longer key press the pulse width is increased by 10%. If 99% is overstepped, 100% is subtracted from the result. The frequency generation can also be finished with a very long key press (> 1.3 s).



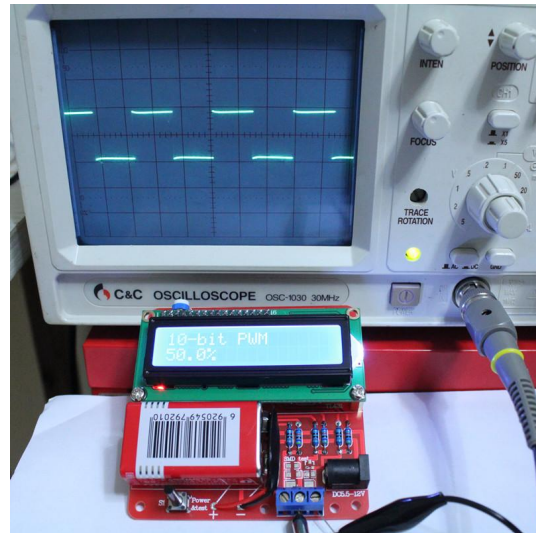
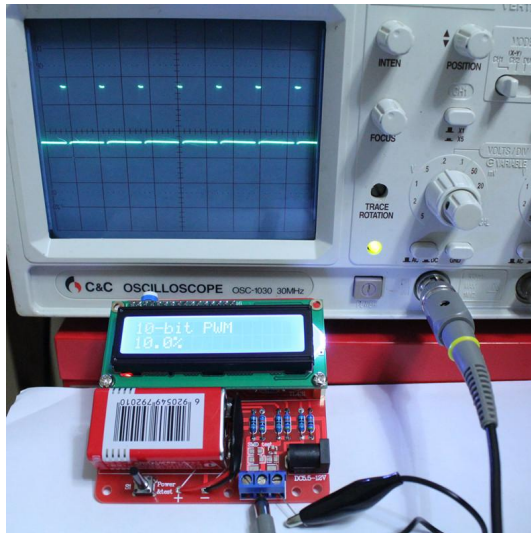

C+ESR(@TP1-3):

The additional function "C+ESR@TP1-3" selects a stand-alone capacity measurement with ESR (Equivalent Series Resistance) measurement at the test pins TP1 and TP3. Capacities from 2 μ F up to 50mF can be measured. Because the measurement voltage is only about 300mV , in most cases the capacitor can be measured "in circuit" without previous disassembling. The series of measurements can be finished with a long key press.

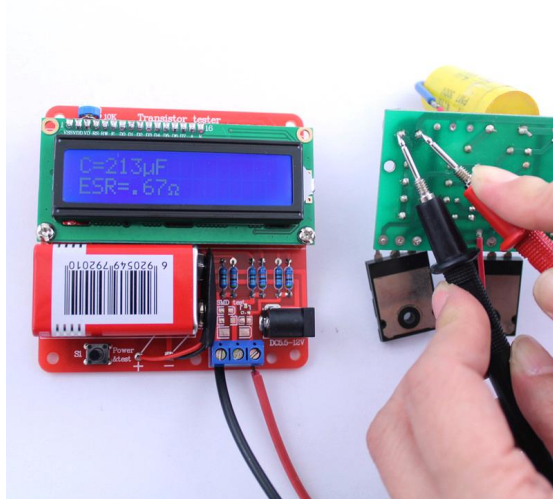

You should be shure, that no residual voltage remains in the equipment.

Rotary Encoder: disable

Selftest :

With the menu function "Selftest" a full selftest with calibration is done. With that call all the test functions T1 to T7 and also the calibration with external capacitor is done every time.

Switch off:

With the additional function "Switch off " the tester can be switched off immediately.

Show data:

The function "Show Data" shows besides the version number of the software and the data of the calibration.

Transistor:

Of course you can also select the function "Transistor" (Transistor tester) to return to a normal Transistor tester measurement.

Circuit diagram:

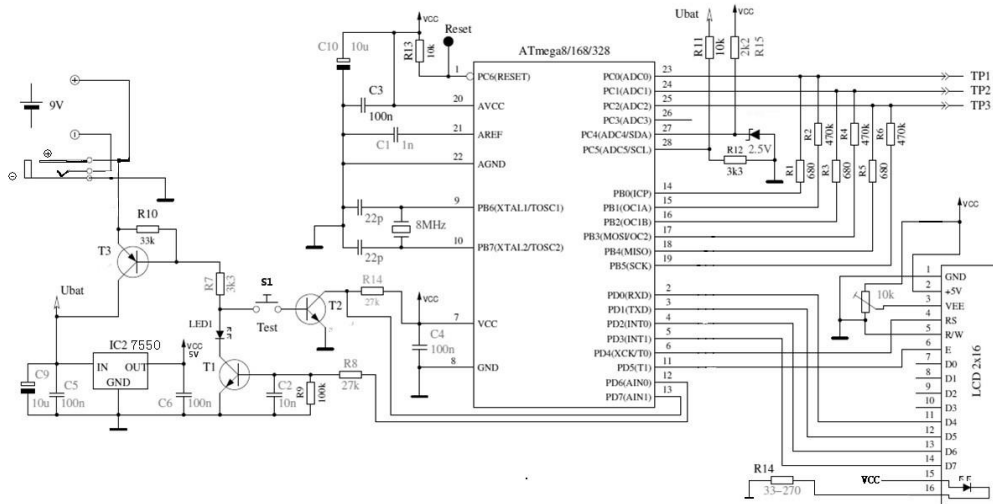

We are confident that this instrument will be of great help to you. Hope you will have delight in your DIY journey!