

Product Summary

V_{RRM} (V)	I_o (A)	V_F (MAX) (V) @ +25°C	I_R (MAX) (mA) @ +25°C
100	2x15	0.85	0.1

Description

High voltage dual Schottky rectifier suited for switch mode power supplies and other power converters. This device is intended for use in medium voltage operation, and particularly, in high frequency circuits where low switching losses and low noise are required.

The MBR30100C is available in standard TO-220-3 (2) and TO-220F-3 (Option 1) packages.

Applications

- Power Supply Output Rectification
- Power Management
- Instrumentation

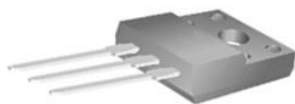

TO-220F-3 (Option 1)

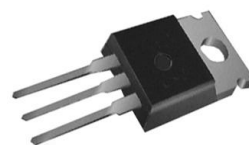

TO-220-3 (2)

- Notes:
1. EU Directive 2002/95/EC (RoHS) & 2011/65/EU (RoHS 2) compliant. All applicable RoHS exemptions applied.
 2. See http://www.diodes.com/quality/lead_free.html for more information about Diodes Incorporated's definitions of Halogen- and Antimony-free, "Green" and Lead-free.
 3. Halogen- and Antimony-free "Green" products are defined as those which contain <900ppm bromine, <900ppm chlorine (<1500ppm total Br + Cl) and <1000ppm antimony compounds.

Pin Assignments

(Front View)

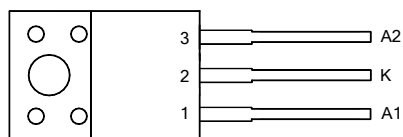

TO-220F-3 (Option 1)

(Front View)

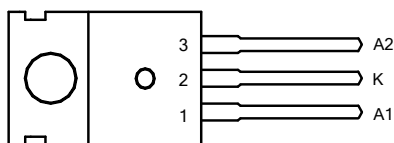



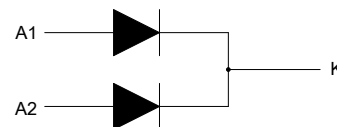

TO-220-3 (2)

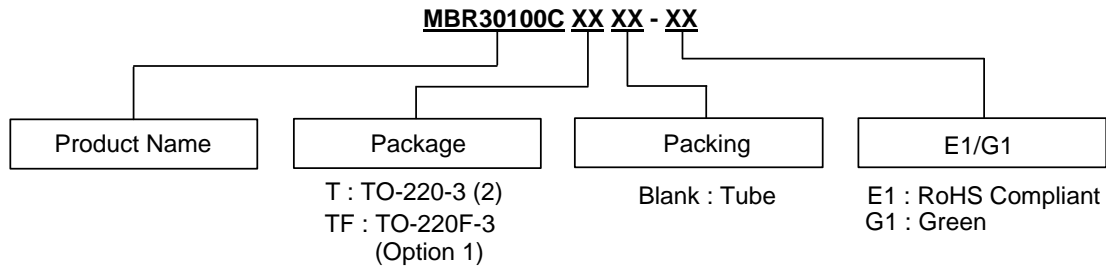

Internal Structure of MBR30100C

Ordering Information (Note 4)

- Notes:
4. Diodes IC's Pb-free products, as designated with "E1" suffix in the part number, are RoHS compliant. Products with "G1" suffix are available in green packages.
 5. Not recommended for new design.
 6. Recommended MBR(F)30100CT-LJ for new design, MBR(F)30100CT-LJ can replace the "G1" products.

	Package	Part Number	Marking ID	Packing
	TO-220-3 (2)	MBR30100CT-E1 (Note 5)	MBR30100CT-E1	50 Pieces/Tube
	TO-220-3 (2)	MBR30100CT-G1 (Note 6)	MBR30100CT-G1	50 Pieces/Tube
	TO-220F-3 (Option 1)	MBR30100CTF-E1 (Note 5)	MBR30100CTF-E1	50 Pieces/Tube
	TO-220F-3 (Option 1)	MBR30100CTF-G1 (Note 6)	MBR30100CTF-G1	50 Pieces/Tube

Marking Information

(1) TO-220-3 (2)

(Front View)

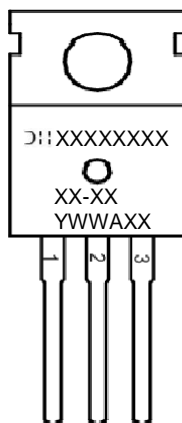

First and Second Lines: Logo and Marking ID
 (See Ordering Information)
 Third Line: Date Code
 Y: Year
 WW: Work Week of Molding
 A: Assembly House Code
 XX: 7th and 8th Digits of Batch Number

Marking Information (Cont.)

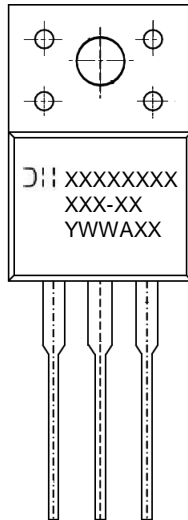
(2) TO-220F-3 (Option 1)
(Front View)

First and Second Lines: Logo and Marking ID
 (See Ordering Information)
 Third Line: Date Code
 Y: Year
 WW: Work Week of Molding
 A: Assembly House Code
 XX: 7th and 8th Digits of Batch Number

Maximum Ratings (Per Diode Leg) (Note 7)

Characteristic	Symbol	Rating	Unit
Peak Repetitive Reverse Voltage Working Peak Reverse Voltage DC Blocking Voltage	V_{RRM} V_{RWM} V_R	100	V
Average Rectified Forward Current (Rated V_R) $T_C = +107^\circ\text{C}$	$I_{F(AV)}$	15	A
Peak Repetitive Forward Current (Rated V_R , Square Wave, 20kHz) $T_C = +98^\circ\text{C}$	I_{FRM}	30	A
Non Repetitive Peak Surge Current (Surge Applied at Rated Load Conditions Half Wave, Single Phase, 60Hz)	I_{FSM}	200	A
Operating Junction Temperature Range (Note 8)	T_J	+150	$^\circ\text{C}$
Storage Temperature Range	T_{STG}	-55 to +150	$^\circ\text{C}$
Voltage Rate of Change (Rated V_R)	dv/dt	10000	V/ μs
ESD (Machine Model = C)	–	> 400	V
ESD (Human Body Model = 3B)	–	> 8000	V

Notes: 7. Stresses greater than those listed under "Absolute Maximum Ratings" may cause permanent damage to the device. These are stress ratings only, and functional operation of the device at these or any other conditions beyond those indicated under "Recommended Operating Conditions" is not implied. Exposure to "Absolute Maximum Ratings" for extended periods may affect device reliability.

8. The heat generated must be less than the thermal conductivity from Junction-to-Ambient: $dP_D/dT_J < 1/\theta_{JA}$.

Thermal Characteristics

Characteristic	Symbol	Rating		Unit
Maximum Thermal Resistance (Junction to Case) (Note 9)	$R_{\theta JC}$	TO-220-3 (2)	2.5	°C/W
		TO-220F-3 (Option 1)	4.5	
Maximum Thermal Resistance (Junction to Ambient) (Note 9)	$R_{\theta JA}$	TO-220-3 (2)	60	°C/W
		TO-220F-3 (Option 1)	60	

Note 9: Device mounted on heat sink, with minimum recommended pad layout per <http://www.diodes.com>

Electrical Characteristics

Characteristic	Symbol	Rating	Unit	Test Condition
Maximum Instantaneous Forward Voltage Drop (Note 10)	V_F	0.85	V	$I_F = 15A, T_C = +25^\circ C$
		0.75		$I_F = 15A, T_C = +125^\circ C$
		0.95		$I_F = 30A, T_C = +25^\circ C$
		0.85		$I_F = 30A, T_C = +125^\circ C$
Maximum Instantaneous Reverse Current (Note 10)	I_R	6.0	mA	Rated DC Voltage, $T_C = +125^\circ C$
		0.1		Rated DC Voltage, $T_C = +25^\circ C$

Note 10: Short duration pulse test used to minimize self-heating effect, Pulse Test: Pulse Width = 300µs, Duty Cycle ≤ 2.0%.

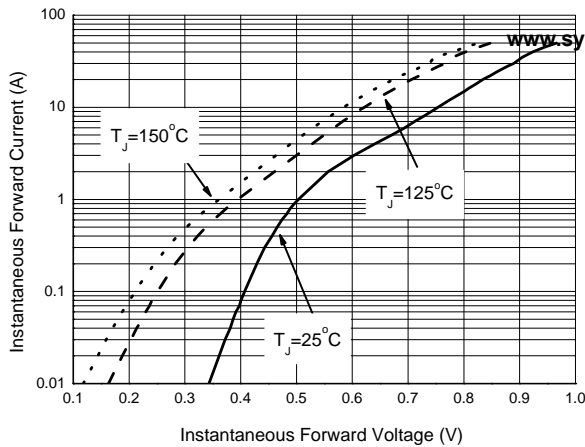

Figure 1. Typical Forward Voltage Per Diode

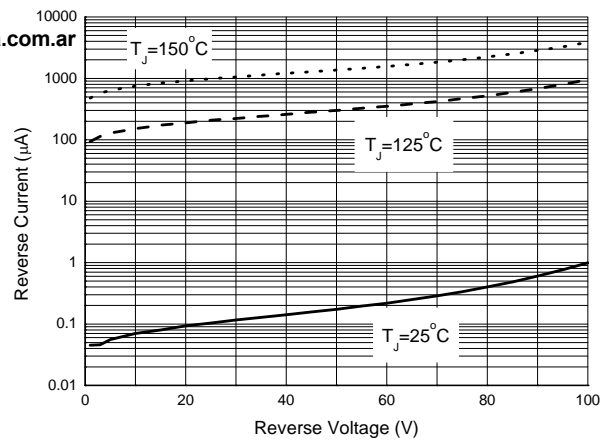

Figure 2. Typical Reverse Current Per Diode

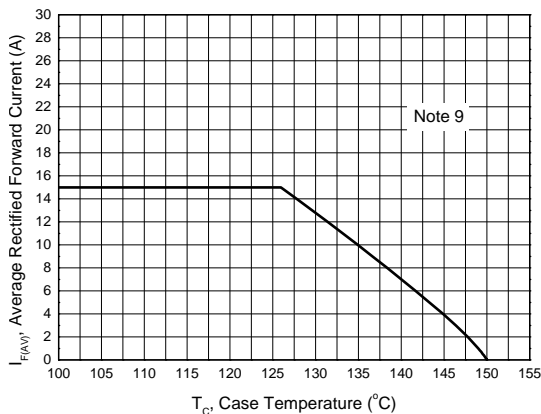
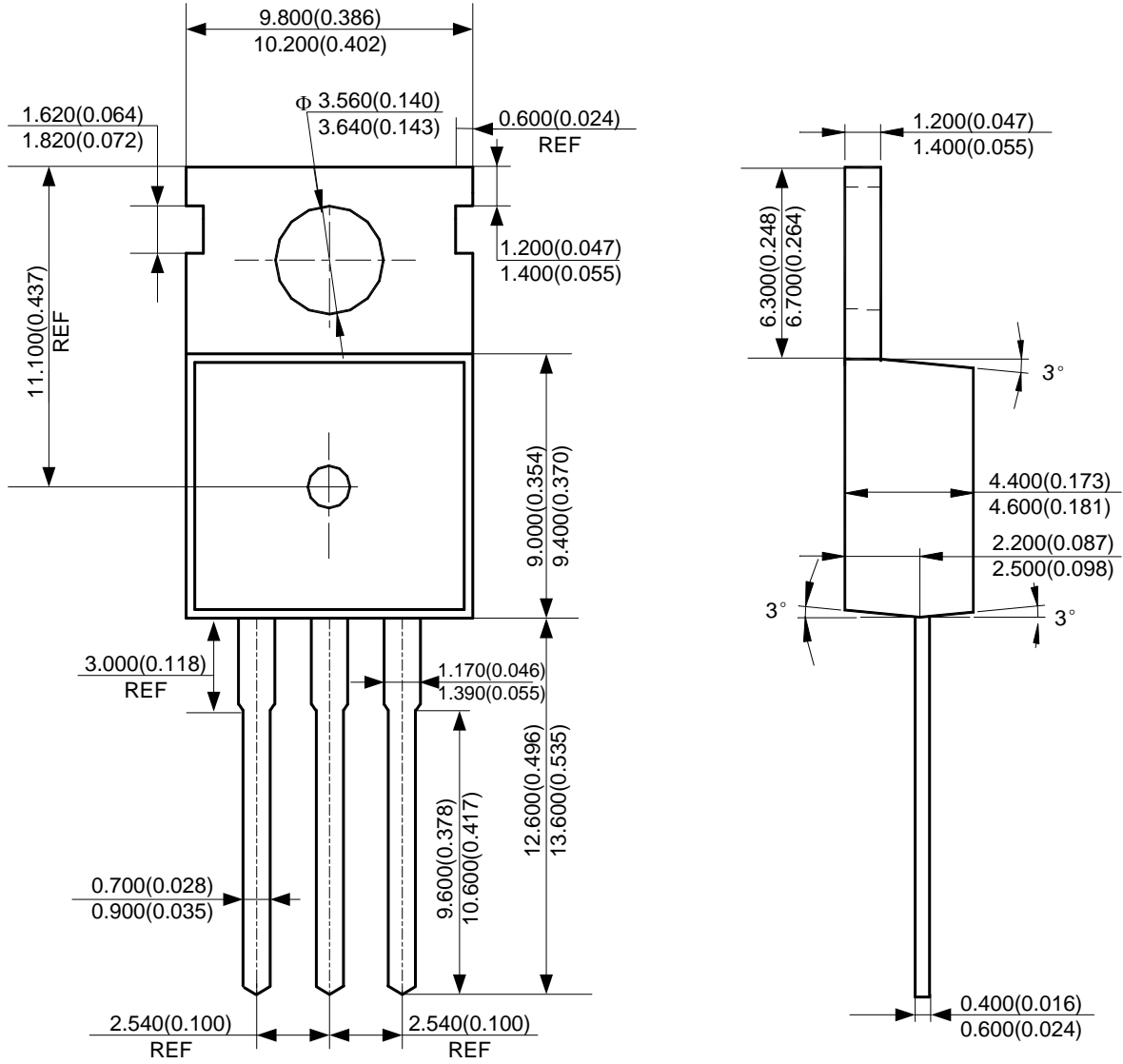

Figure 3. Average Rectified Forward Current vs. Case Temperature (Square, Per Diode)

Package Outline Dimensions (All dimensions in mm(inch).)

(1) Package Type: TO-220-3 (2)



Package Outline Dimensions (Cont. All dimensions in mm(inch).)

(2) Package Type: TO-220F-3

